

## TROUBLESHOOTING

LED indicators are provided to assist with troubleshooting. The following lists the specific LED's and their function(s).

### 1. RX OUTPUT RELAY LEDs

Each output relay on the receiver is supplied with an LED indicator beside the relay to indicate when the relay is powered. If no output function is evident, but the LED is ON, then the relay, the wiring, or the controlled equipment may be at fault.

### 2. RX POWER LED

The receiver POWER LED (see Fig. 1) indicates that the electronics power supply is functioning correctly. This LED should be on steady when ever the receiver is powered.

### 3. RX ERROR LED

The receiver EROR LED (see Fig. 1) will flash slowly (every 0.5 sec) to indicate an internal memory failure. Contact the Distributor for repair.

### 4. RX CARRIER LED

The receiver CARRIER LED (on the rear of the receiver lid) will light to indicate that a signal is being received from the Transmitter. If no signal is received check that the transmitter is the correct unit for that receiver (channel and model), and that it has been programmed for the specific RX ID (see Remote Setting). Also check that the TX LEDs are indicating proper operation of the TX unit. If the TX is out of range of the RX, then the carrier LED will not light. Also ensure that the Receiver unit (and Antenna) is installed correctly with the proper orientation and without interference.

### 5. TX RED LED

If the TX LED flashes slowly red (every 0.5 sec) the TX memory is defective. Contact the Distributor for repair. If the TX LED flashes quickly red (every 0.2 sec) when a pushbutton is pressed, the following reasons may be the cause:

- One of the pushbuttons is jammed
- The system has not been "started" according to the instructions.

If the TX LED remains on steady red, remove and re-insert the batteries. If the TX does not respond at all, power it off for 20 seconds, and then retry. If this does not correct the problem, contact the Distributor for repair.

## WARRANTY and DISCLAIMER

The manufacturer warrants its products against defects in material and workmanship for a period of 1 year from date of shipment. During the warranty period, the manufacturer will repair and/or replace defective components at no charge, as long as it can be proven that the failure of the product was due to defective material or workmanship. The defective product must be returned to an authorized service center (freight prepaid) for consideration of warranty. The manufacturer will not be liable for any damages to the warranted product outside of the above mentioned reason of defective material or workmanship. Also, the manufacturer does not warranty and "consumable" parts such as and not limited to batteries, fuses, buttons, or relays. This warranty also does not include damages caused by improper installation, improper or insufficient maintenance, unauthorized modification, improper operation, or improper interfacing. No other warranty is expressed or implied.

The manufacturer and its employees, agents, distributors, dealers and authorized representatives shall in no event be held liable for any consequential or inconsequential damages or damages for injury to person or property due to the failure of the customer to comply with safety requirements or arising out of the failure or malfunction of the remote controls. The customer furthermore releases and indemnifies and saves harmless the manufacturer and its employees, agents, distributors, dealers and authorized representatives in respect of any such consequential or inconsequential damages or damages for injury to person or property.

## WARNING

**WARNING: Failure to follow these guidelines and any other applicable guidelines, regulations or standards as set out by the equipment manufacturer(s), applicable standards authorities, and the local safety authorities could result in injury, death or property damage.**

For the most recent version of these guidelines, or for additional information or assistance, please contact the appropriate equipment manufacturer.  
For the most recent version of the applicable regulations, or for additional information, please contact your local safety or workers compensation office.  
For information on applicable standards, contact the appropriate standards branch or association.

# D21-2D

## INSTALLATION and OPERATION

### INSTALLATION - General

- The receiver unit should be installed on the top of the electrical control cabinet or panel.
- It is preferred that the Receiver be installed horizontally such that the antenna is vertical.
- To avoid possible interference with RF signals, the receiver should be installed at least three (3) meters away from motors, frequency converters, variable frequency drives, and related power cables.
- Do not extend the antenna connection with a cable. The sensitivity of the receiver will be severely degraded.
- Install the receiver such that the antenna has an open view of the operating area with no metal objects immediately surrounding the antenna.
- Always keep the receiver lid closed tightly to avoid dirt and contamination within the receiver unit.



D21-2D  
dual speed



Receiver

### INSTALLATION - Voltage Setting

The receiver unit as shipped from the factory is set for 110 Volt AC operation. If the receiver will be operated from 220 Volt AC power source, then the internal voltage selection jumper must be changed.

#### Voltage Jumper Setting

HI position 220 VAC  
LO position 110 VAC

**Always ensure power is disconnect from the receiver unit before attempting any setting adjustment or wiring connections.**

Locate the HI / LO jumper in the receiver unit located to the left of the transformer (see Fig. 1). Remove and re-install the jumper for the appropriate voltage setting.

**Caution: Damage may result if the incorrect voltage is applied to the receiver unit.**

### INSTALLATION - Connection

Fig. 2 indicates the internal connection of the receiver unit. Receiver units supplied with a pre-wired cable are connected as shown. Fig. 1 shows the main connector and the function name of each pin.

For installations where separate signal commons are required for UP1S/UP2S and/or DN1S/DN2S signal pairs, the appropriate colored jumper wire(s) in the receiver (see Fig. 2), may be cut off at the end designated with an X in Fig. 1. The remaining wire will become the new common for that signal pair.

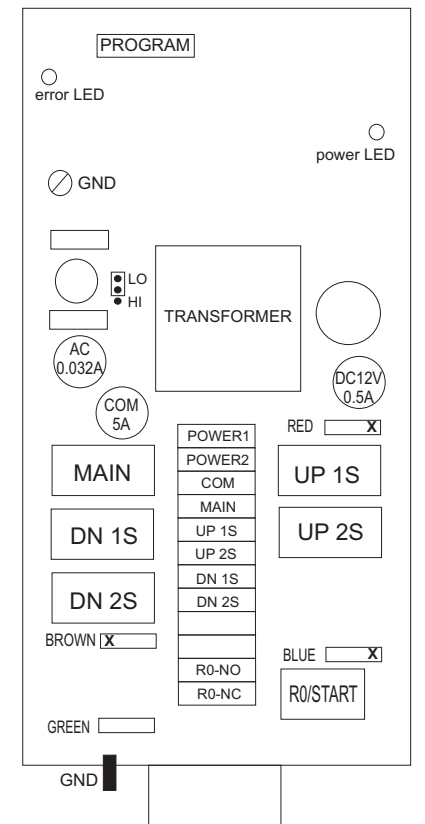

Fig. 1 Internal Layout Diagram

## INSTALLATION - COM and MAIN Wires

For standard installations, the COM wire should be used so that all relays including the MAIN relay will be turned off when the Emergency Stop (EMS) button is pressed.

In some special cases, such as when an output is programmed as an ON/OFF function or a TOGGLE function with the EMS control bypassed, it will be necessary to use the MAIN wire as the COM wire and the COM wire as the MAIN wire (MAIN relay output).

**ALWAYS use caution when disabling or bypassing EMS functions.**

## INSTALLATION - R0/START NO to NC

The factory default setting for the R0/START output wiring is a NO (normally open) connection.



In cases where a NC (normally closed) output is necessary, remove the #11 wire from the connector shell (inside the receiver housing) and re-insert it into the #12 unused bottom position of the connector (see Fig. 1).

**Always ensure power is disconnect from the receiver unit before attempting any setting adjustment or wiring connections.**

## INSTALLATION - Batteries

Two (2) AA size alkaline batteries are required for the transmitter. Do not use rechargeable batteries as Ni-Cad batteries do not provide the same voltage as alkaline batteries.





The TX LED will flash green when battery power is OK. The LED will flash red when battery power is low.

-  The operating distance will become shorter when the battery is low.
-  Do not leave dead batteries in the TX unit since they may corrode and damage the unit.



## OPERATION

1. Ensure that equipment may be operated safely and is clear of personnel. Refer to original equipment manufacturer's instructions and regulations.
2. Switch on the main power switch of the controlled equipment.
3. Insert magnetic key.
4. Press either UP or DOWN button or follow other programmed start procedure(s) to energize MAIN relay inside unit.
5. Operate normally according to pre-programmed function settings.
6. After operation, (a) press STOP button, (b) remove magnetic key, and switch off the main power to the controlled equipment.

### In case of emergency or malfunction:

-  Press STOP pushbutton
-  Remove Magnetic Key.
-  Switch off main power to equipment.
-  Contact authorized service personnel for assistance.

## CAUTION

-  Safe and approved lockout procedures should be used to prevent intentional or unintentional equipment operation by remote controls during any situation where personnel are at risk of injury.
-  At no time should equipment be operated from a distance or location as deemed unsafe by the applicable Safety Authority, the employer, or the manufacturer of the controlled equipment, or at any time when a clear view of the controlled equipment and nearby personnel is not available, or at any time when it is or may be unsafe to operate.
-  Written Safe Work Procedures must be established that specify at a minimum:
  - a. Maximum distance from which the operator is allowed to control the equipment.
  - b. Specify that workers remain at a safe distance from remotely controlled moving parts and any remotely controlled equipment.

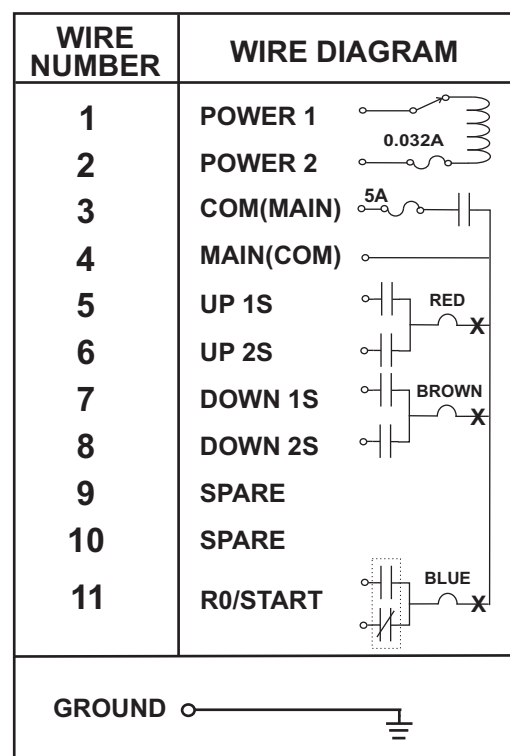

Fig. 2 Connection Diagram

## REMOTE SETTING

In order to work, the TX and RX must both have the same ID CODE and FREQUENCY (or Channel). When supplied from the factory, the ID codes and frequency are the same. In the event an RX or TX must be replaced, it is necessary to ensure that the Frequency of the new unit is the same as the original unit. Also, please follow the procedure below to make the ID codes the same in both units.

- (a) Ensure both TX and RX are same model and frequency.
- (b) In order to avoid interference, place the TX as close as possible to the RX.
- (c) Turn off the RX main power for at least 20 seconds, and then turn it on again.
- (d) You must complete next steps within 4 minutes since the RX will not accept the remote setting signal after four (4) minutes from power up. Otherwise, return to step (c) and begin again.
- (e) Remove the Magnetic Key.
- (f) Press the UP pushbutton and hold it depressed.
- (g) Press the DOWN pushbutton 4 times
- (h) Release the pushbuttons while the red TX LED is flashing
- (i) Start the system as usual and confirm proper operation.

In the event the remote setting failed, repeat the above procedure.

The remote settings procedure will only change ID code and will not change function settings. Consult the distributor for function setting changes.

In the event that the UP and DOWN key labels have been changed for some other function, the UP key is the center button and the DOWN key is the bottom button.

**Caution: All same model systems on the same frequency within operating distance of the transmitter will be paired with the TX ID code. In the case where there are other receivers nearby, ensure they are not powered during the remote setting procedure.**

## FREQUENCY SETTING

The TX and RX units must have the same frequency setting in order to work together. It is possible to change the frequency setting in either or both units if required.

There are two (2) bands of frequencies used namely VHF and UHF. The band used and the specific frequencies used will depend on the RF regulations in your area. The frequency of a TX or RX can only be changed within the same band. If a frequency change of and RX or TX unit is required, please consult your local distributor for available frequencies and additional information.

If you are ordering a spare or replacement RX or TX to be used with an existing RX or TX unit, specify the frequency or channel at the time of ordering the spare or replacement, to avoid inconvenience and possible additional costs to change the frequency later.

## FUSES

Fuses are provided to protect the RX unit from damage due to malfunction or short circuit. If you suspect a fuse has blown, remove it and check it with a suitable fuse tester or ohm meter. For location of fuses see Fig. 1 and for circuit function, see Fig. 2.

**Always replace the fuse with the same type and rating.**

To remove the fuse, depress the fuse cover and turn it gently counterclockwise with a flat screwdriver to open.

To replace the fuse, insert the new fuse into the cover first. Then place the fuse along with the cover into the fuseholder base, depress the fuse cover, and turn it gently clockwise with a flat screwdriver.